



Luminaire rail 3 m 200 mm

E-no — MP-no 341V

White-painted luminaire rail with hole pattern for the most common 3- and 5-pin quick connectors on the market. The rail is made of powder-coated sheet metal and is suitable for environmental class max C2. Painted rails have unpainted ends to ensure good continuity across the splice for potential equalisation. Other lengths, optional colours and hot-dip galvanised rail can be offered on request. Bracket distance is determined by the length of the rail. 2 m rail = c-c 2 m; 3 m rail = c-c 3 m. A 6 m rail needs a wire suspension in the middle. These values apply at normal load.

Product details

E-no	MP-no	EAN
	341V	7394333104355
Dimensions (dxwxh)	Weight kg	Surface
3000x200x45	7.09	White
Environment class	Package pieces	Climate impact (kgCo2e)
C2	4	18.93

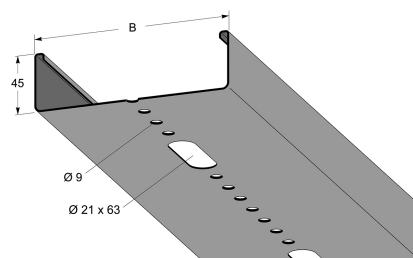

Nedböjning i mm vid 2 m och 3 m konsolavstånd.

