



**Installation units  
made of plastic, quadrangular**  
Assembly instruction



# Installation units made of plastic, quadrangular

## Assembly instruction

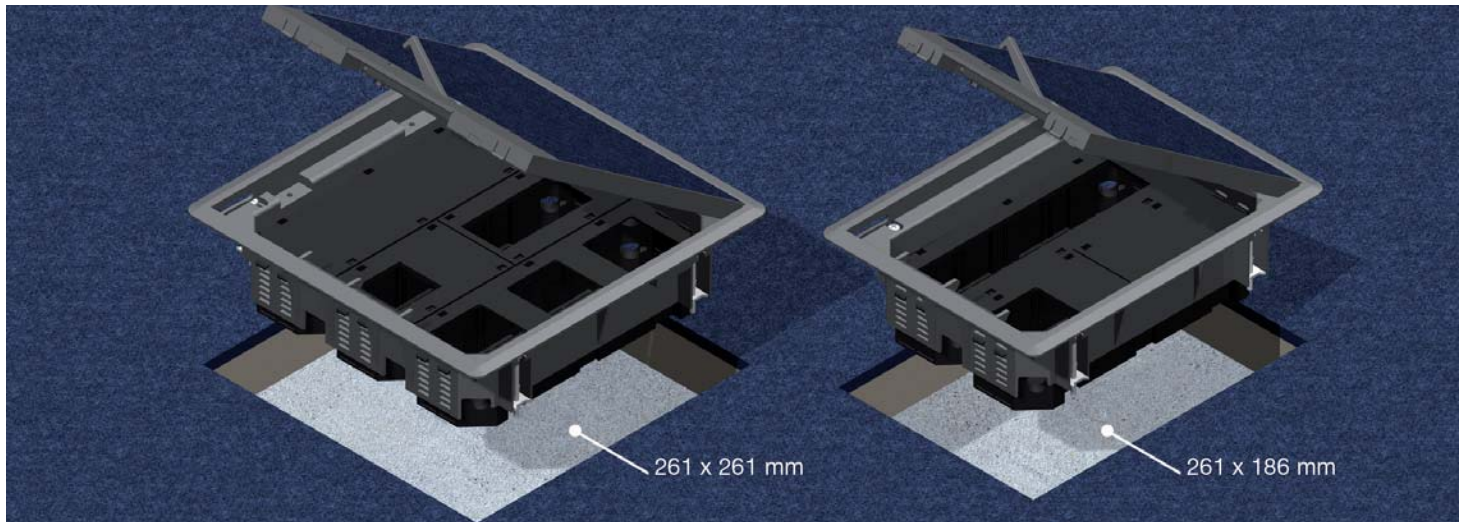

Quadrangular installation units, external dimension 258 x 258 mm or 258 x 184 mm, for installation of up to three device containers.

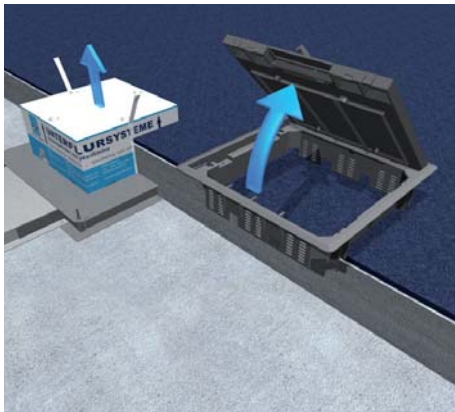

**1 | Screed floors**  
For screed covered systems remove shuttering unit and mount installation unit directly into the installation opening.

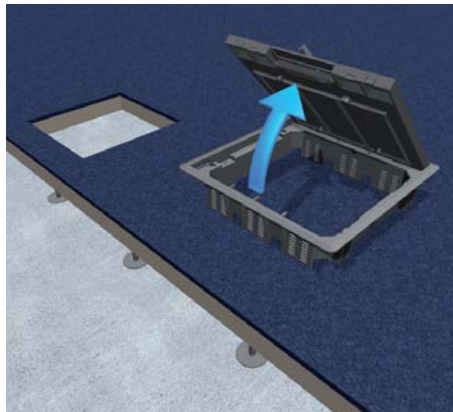

**2 | Hollow space- and raised floors**  
For hollow space and raised floors mount installation unit directly into the installation opening.



**3 | Remove hinged cover**  
Open cover completely, pull firmly forward at the right side and loosen from hinge joint with a screwdriver.

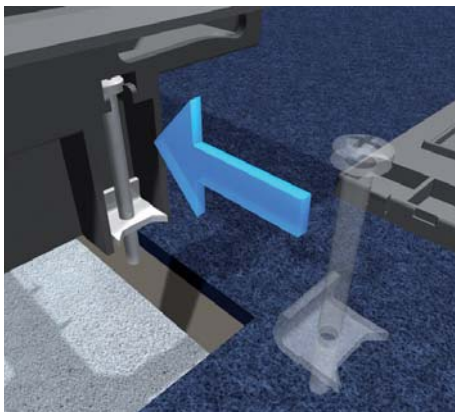

**4 | Mounting claws**  
Mount the enclosed standard claw fasteners (range of claws 30 to 50 mm) into the acceptance in the frame.

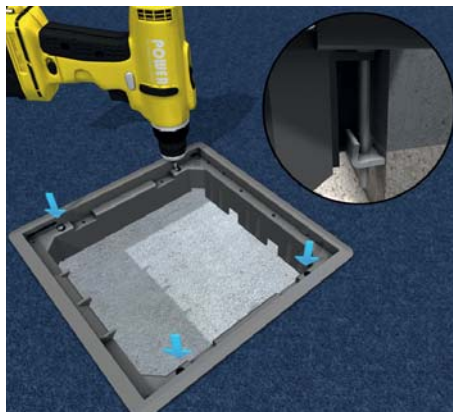

**5 | Fastening the installation frame**  
Insert frame into installation opening from the top and tighten the pre-assembled claws with a crosshead screw. Check to ensure the frame fits tightly.

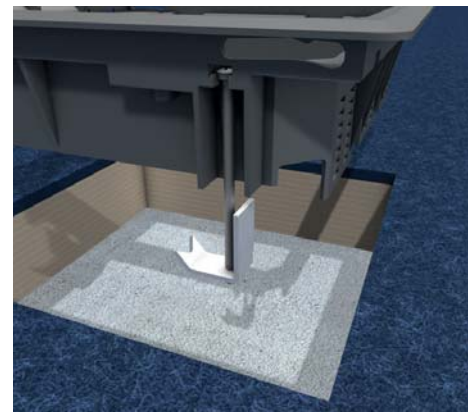

**6 | Claws**  
Custom-made applications require the use of claw UDKS 40-80. If that is the case, the pre-assembled claws are removed and replaced. Turn claw body so that the frame can be inserted from the top.

# Installation units made of plastic, quadrangular

## Assembly instruction



### 7 | The use of claws

The claws UDKS 40-80 stretch under the raised floor panel, into the screed or into the cover plate of the floor box.

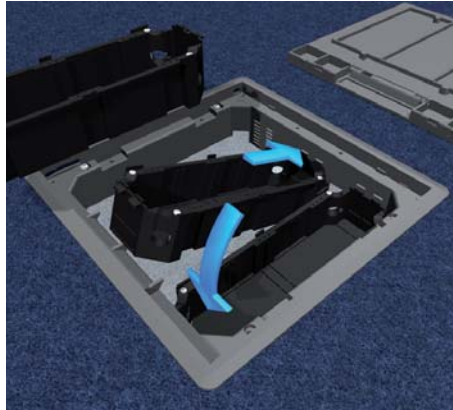

### 8 | Inserting device containers

Click device containers as deep as possible into the lock-in leads.

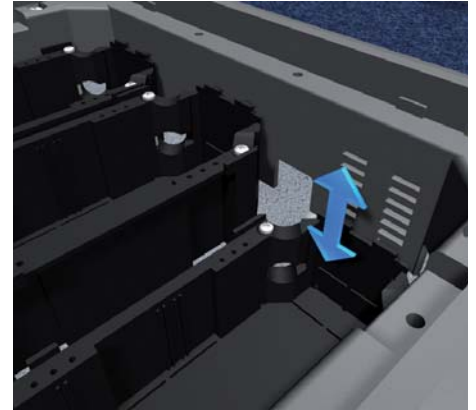

### 9 | Lock-in leads

Lower the device container gradually down to 30 mm.

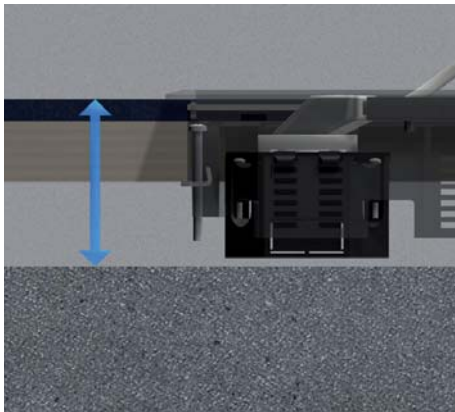

### 10 | Minimum installation height

Minimum installation height 74 mm and 87 mm for device plugs up to H = 35 mm.

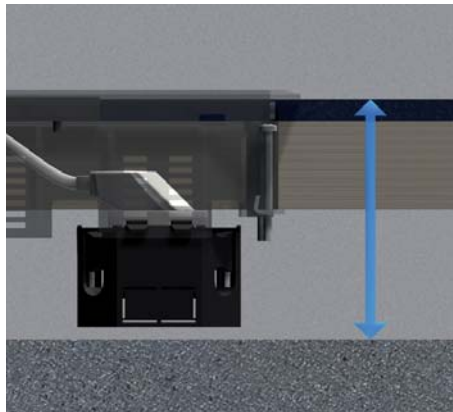

### 11 | Maximum installation height

Maximum installation height 104 mm for device plugs up to H = 50 mm.



### 12 | Loosen device container

Insert screwdriver or mounting lever between frame and device container. Loosen snap tab and remove device container.

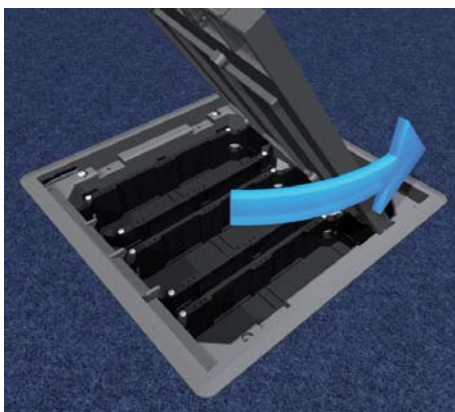

### 13 | Insert hinged cover

Attach opened hinged cover at the left back side, push firmly to the back on the right side and snap into hinged-joint.

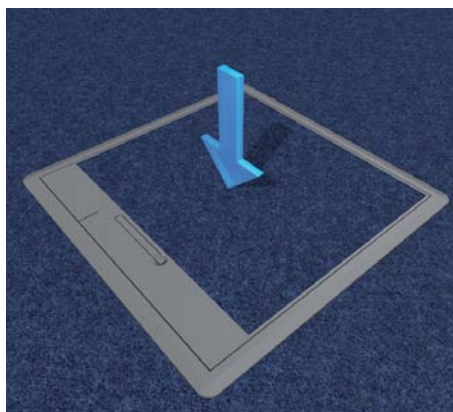

### 14 | Glue in bottom covering

Cut bottom coverings up to 8 mm accurately and glue to the steel insert. Optional lid insert H = 3 mm.

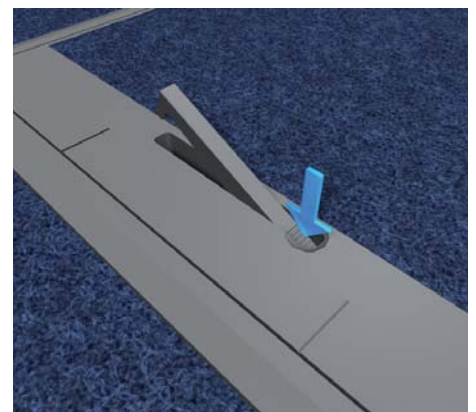

### 15 | Opening lever

Self-locking opening lever is behind the cable outlet.

## Installation units made of plastic, quadrangular

### Assembly instruction

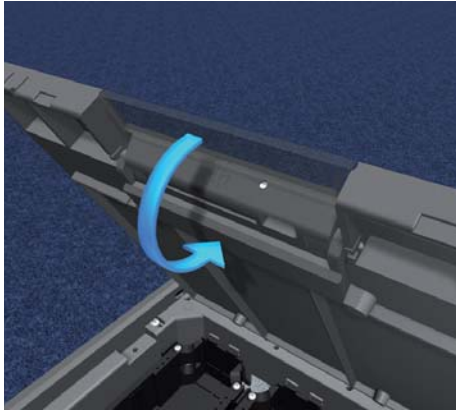

#### 16 | Cable outlet

Swing around carriage cover by 180° and snap in.

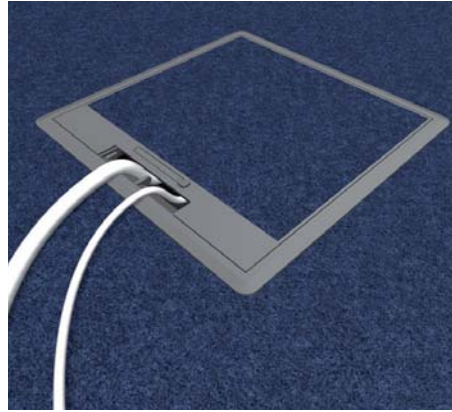

#### 17 | Lead cables through

Lead cables through the open cable outlet.

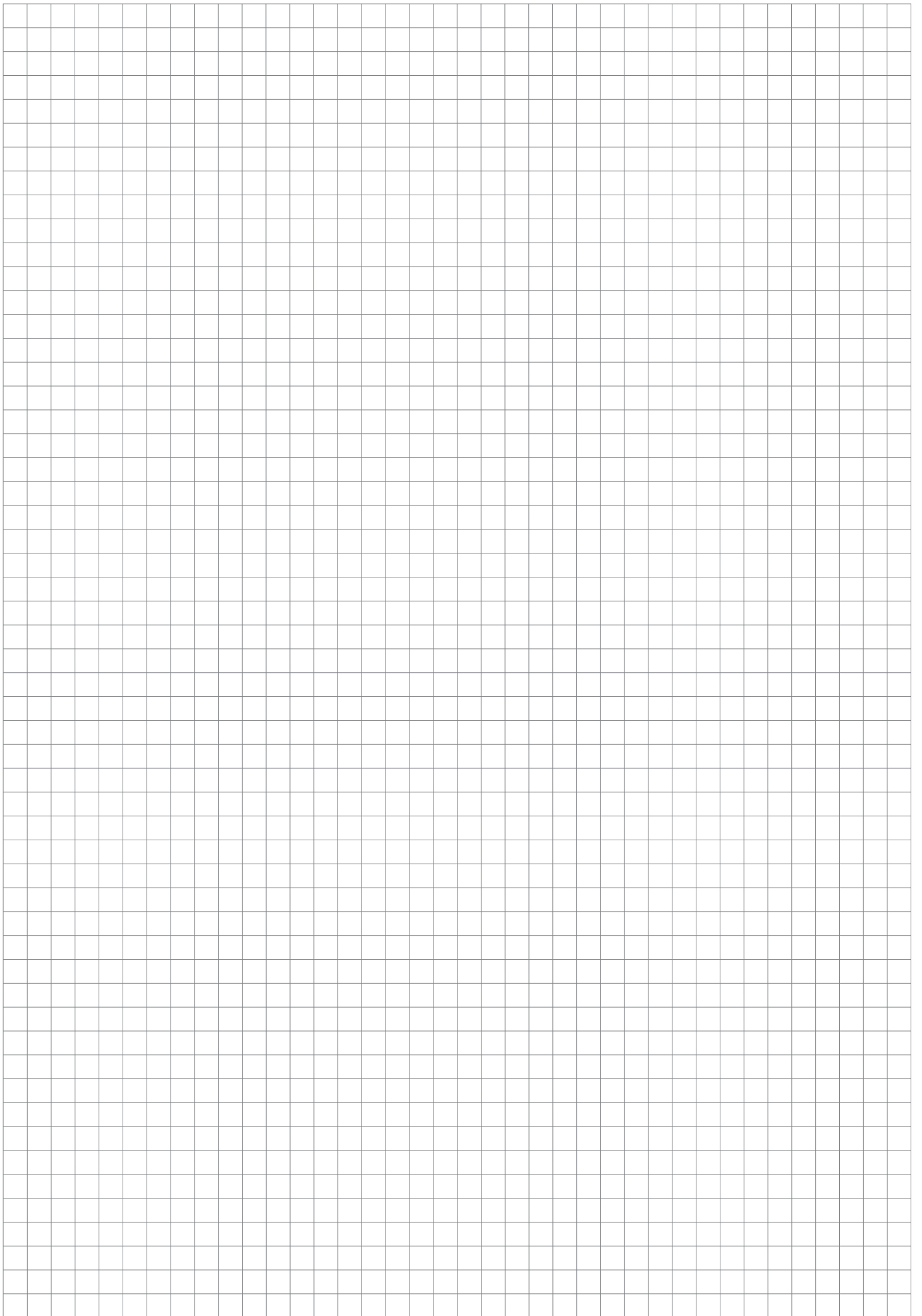



Errors and technical modification subject to change, reproduction as well as electronic duplication only with our written permission. With appearance of this print all preceding documents lose their validity.

