

MP*bolagen*

Quick guide

Your guide to creative solutions.



Quick guidance & material selection.

Cable ladders – wire mesh trays – luminaire rails – profiles – cable trays – service poles/posts – wall trunkings – lightning rails – floor boxes.



*We are a natural partner and your best support.
Please feel free to contact us – see page 28.*

Quick guidance & material selection.

This brochure contains items available at wholesale distributors' central warehouses, installers' top choices, and the best-selling products according to our own statistics. The complete range is available in the MP catalog – order at info@mpbolagen.se.

Some of the accessories are specifically designed for C4 environments but also suitable for lower corrosion classes, reducing the number of items/stock locations.

Table for corrosivity classes.

Corrosivity class according to SS-EN ISO 12944-2, taking into account the corrosivity of the atmosphere and environment examples.

Corrosivity-class	Environment's corrosivity	Examples of typical environments in the temperate climate zone (informative).	
		Outdoor	Indoor
 C1	Very low		Heated areas with dry and insignificant amounts of contamination, for example, offices, shops, schools and hotels.
 C2	Low	Atmospheres with low content of air contamination Rural areas.	Non-heated areas with varying temperatures and humidity. Low frequency air of condensation and low levels of air contamination, for example, sports halls and warehouses.
 C3/C4	Moderate	Atmosphere with small quantities of salt or moderate amounts of air contamination. Urban areas and light industrial areas. Areas with some influence from the coast.	Areas with moderate humidity and some air contamination from production processes, for example, breweries, dairies and laundries.
	High	Atmosphere with a moderate quantity of salt or tangible quantities of air contamination, in industrial and coastal areas.	Areas with high humidity and large quantities of air contamination from production processes, for example, chemical plants, swimming pools.
 C5-I	Very high (industrial)	Industrial areas with high humidity and aggressive atmosphere.	Areas with almost permanent moisture condensation and large levels of air contamination.
 C5-M	Very high (marine)	Coastal and offshore areas with large amounts of salt.	Areas with almost permanent moisture condensation and large levels of air contamination.

List of contents

- 4-5** Cable ladders MP-S- and TS
- 6-7** Cable ladders MP-Z- and Z4
- 8-9** Cable ladders MP-FZ – self-supporting
- 10-11** Cable ladders – stainless steel
- 12-13** Wire mesh trays
- 14-15** Trays/luminaire rails
- 16-17** Ductel – wall trunkings aluminum
- 18-20** Global Trac - track lightning
- 21** Service poles – posts
- 22-24** Floor boxes
- 25** 19"-racks – telecom/data
- 26** Profiles
- 27** ABB low-voltage products.
- 28** Contacts

Cable ladders MP-S and TS

Sendzimir 20 µm – Corrosivity class max C2

Choosing right Cable ladder!

MP-S Cable ladder with 20 µm Sendzimir coating and perforated rungs – rungs 2 and 4 are closed. MP-TS with 20 µm Sendzimir coating has closed rungs. Normal bracket spacing center-to-center is 2 meters. Manufactured and adapted for indoor use in corrosivity class up to C2 – read more on page 2. (Joint meets requirements for electrical continuity with a good margin.)

MP-S is available in 3- and 6-meter lengths. MP-TS is available in 6-meter lengths.

Note!

MP Angle bracket (11 153 85) is universally applicable for a wide range of products throughout the entire MP range!

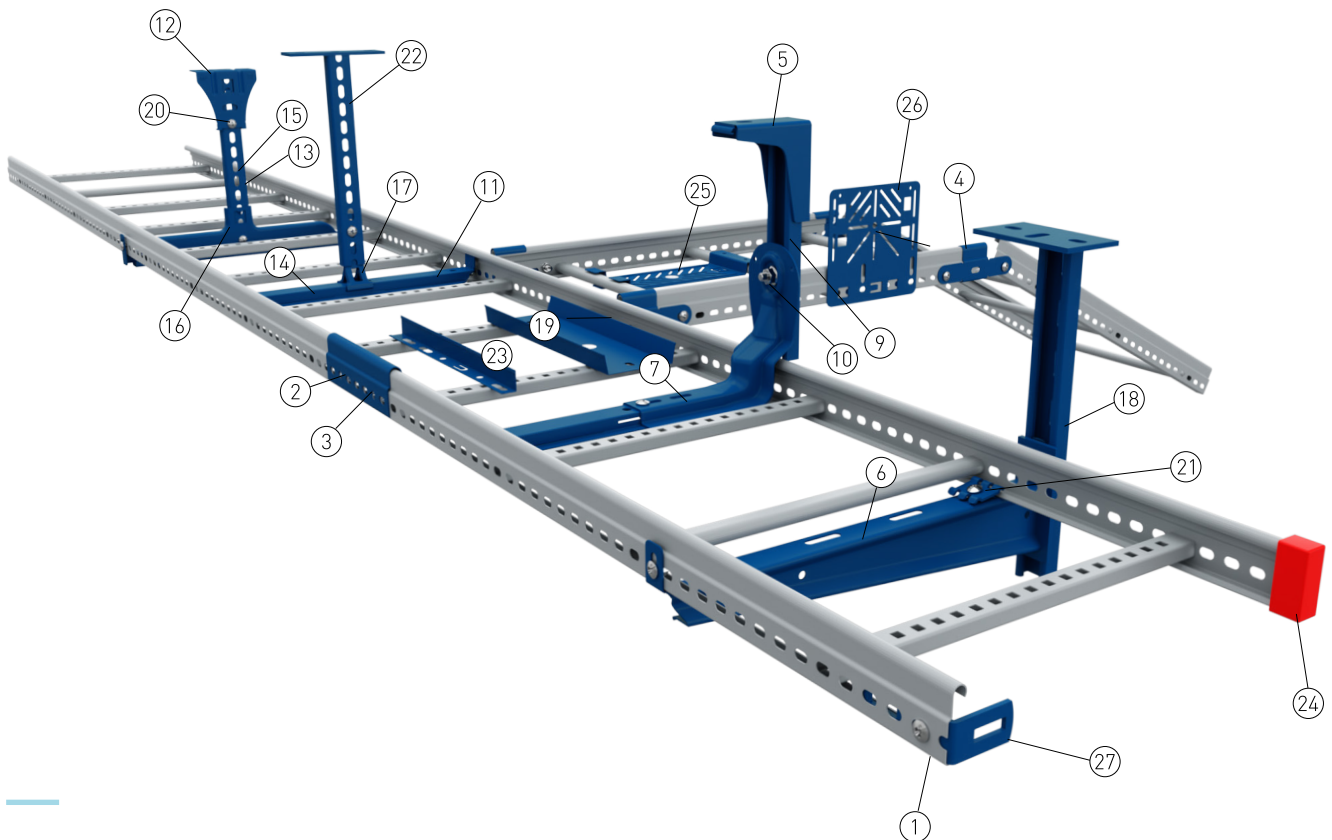

Ladders and accessories.

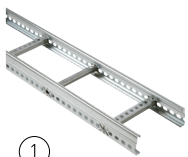

Ladder MP-S	Length	Width
11 150 23	3000	200
11 150 26	3000	300
11 150 29	3000	400
11 150 32	3000	500
11 150 35	3000	600

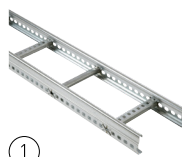

Ladder MP-S	Length	Width
11 150 24	6000	200
11 150 27	6000	300
11 150 30	6000	400
11 150 33	6000	500
11 150 36	6000	600

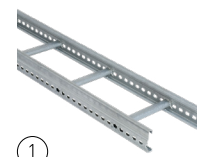

Ladder MP-TS	Length	Width
11 150 43	6000	200
11 150 46	6000	300
11 150 49	6000	400
11 150 52	6000	500
11 150 55	6000	600

Deflection in mm at bracket spacing 2-3 m.

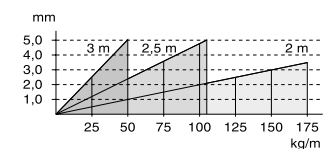
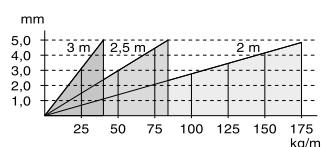
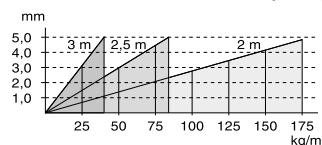

Cable ladders MP-S and TS

E-number – dim. (mm) – accessories



Spice
11 153 63
Placed
external



Splice
11 153 60
Placed
internal

Fits only MP-S
Cable ladders.



Universal link
11 153 74
Placed
external

Ceiling pendant with loose details – side mounting



Ceiling bracket
11 157 97
Lenght
100
Height
104



Cantilever arm
11 165 52
11 165 61
11 165 70
11 165 74
11 165 80
Width
200
300
400
500
600
Max.load
150
150
150
150
150



Cantilever arm
11 172 05
11 172 09
Placed
internal
internal
Width
200
300-600



Anchor rail
11 158 39
11 158 47
11 158 02
Lenght
250
500
3000
Width
200
300
400



Cantilever arm
11 151 76
11 151 79
11 151 82
11 151 85
11 151 88
Width
200
300
400
500
600
Max.load
200
200
250
370
370



Support yoke
11 152 95
11 152 98
11 153 01
11 153 04
11 153 07
11 174 82
Width
200
300
400
500
600
Placed
internal
internal
internal
internal
lock yoke



T-screw
11 158 22
Size
M10x35

Ceiling pendant with loose details –center mounting



Ceiling bracket
11 153 46
Height
100
Width
102



Splice pendant
11 153 11
Lenght
250
Width
30



Support yoke
11 152 95
11 152 98
11 153 01
11 153 04
11 153 07
Width
200
300
400
500
600
Placed
internal
internal
internal
internal
internal

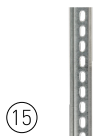

Pendent rail
11 153 26
11 153 32
11 153 38
Lenght
300
500
3000
Width
35
35
35



Support yoke
11 152 23
11 152 26
11 152 29
11 152 32
11 152 35
Width
200
300
400
500
600
Placed
external
external
external
external



Pendant bracket
11 173 87
Height
102

Fixed Ceiling pendant/accessories



Ceiling pendant
11 157 28
11 157 32
11 157 36
Lenght
500
750
1000
Placed
side
side
side



Telecom channel
11 156 00
11 156 04
11 156 12
11 156 16
Width
50
100
50
100
Model
unperforated
unperforated
perforated
perforated



Fastening screw
11 157 11
Accessories – mounting
M8x16 [50 pcs/pack.]



Ceiling pendant
11 157 04
11 157 08
11 157 12
Length
300
500
1000
Placed
center
center
center



Divider
11 184 72
11 184 78
11 184 73
Height
25
40
–
Length
2750
2750
joint



Universal bracket
11 165 30
(int. bracket clamp)



End protection
11 152 92



Luminaire plate
11 155 73



Mounting plate
11 155 79



Angle bracket
11 153 85
11 153 81
Length
90
200

Cable ladders MP-Z and Z4

Z 60 µm and Z4 – Corrosivity class max C4

Choosing right Cable ladder!

Cable ladders MP-Z and Z4 with closed rungs. Normal bracket spacing center-to-center is 2 meters. All items on this page are adapted for a maximum corrosion class of C4. Read more about corrosion classes on page 2. (Joint meets requirements for electrical continuity with a good margin).

Note!

Z4 has a self-healing capability that makes the material resistant to various factors, including corrosion caused by scratches. Z4 can also be placed in alkaline environments!

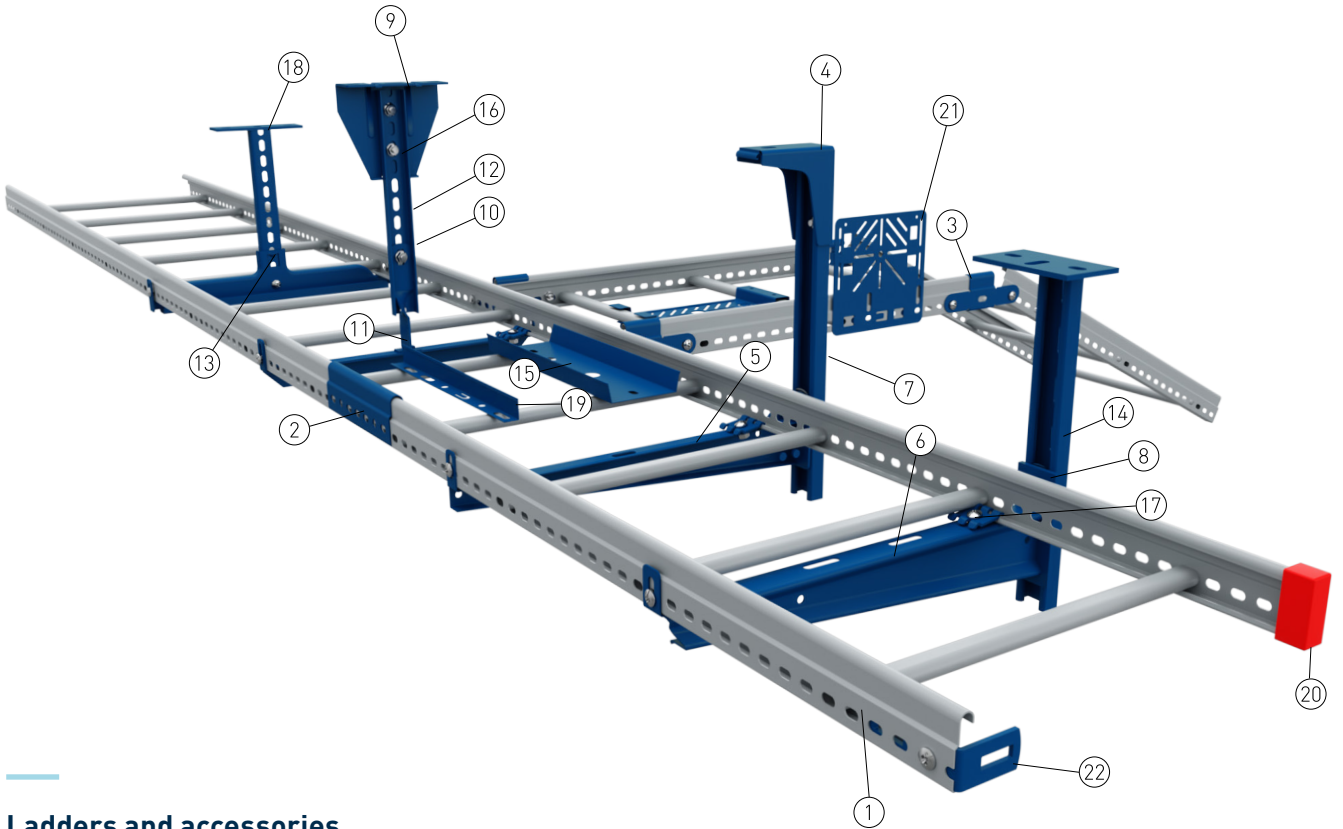

Ladders and accessories.



①

Ladder MP-Z	Length	Width
11 150 63	6000	200
11 150 66	6000	300
11 150 69	6000	400
11 150 72	6000	500
11 150 75	6000	600



①

Ladder MP-Z4	Length	Width
11 151 02	6000	200
11 151 03	6000	300
11 151 04	6000	400
11 151 05	6000	500
11 151 06	6000	600

Deflection in mm at bracket spacing 2-3 m.

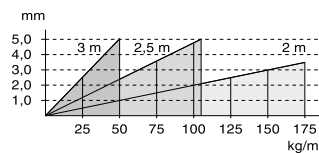
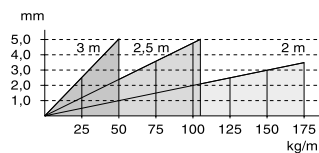

Cable ladders MP-Z and Z4

E-number – dim. (mm) – accessories

②		Placed	Mtrl.
	Splice	external	Z
	11 153 65	external	Z4
	11 153 61	external	Z4

③		Placed	Mtrl.
	Universal link	external	Z
	11 153 76	external	Z4
	11 153 56	external	Z4

Ceiling pendant – side mounting

④		Length	Height
	Ceiling bracket	100	104
	11 157 98		

⑤		Width	Max.load
	Cantilever arm	200	150
	11 165 55	300	150
	11 165 64	400	150
	11 165 73	500	150
	11 165 78	600	150
	11 165 84		

⑥		Width	Max.load
	Cantilever arm	200	200
	11 151 76	300	200
	11 151 79	400	250
	11 151 82	500	370
	11 151 85	600	370
	11 151 88		

⑦		Length	Width
	Anchor rail	250	41
	11 158 40	500	41
	11 158 48	3000	41
	11 158 00		

⑧		Size
	T-screw	M10x30
	11 158 15	

Ceiling pendant – center mounting

⑨		Height	Width
	Ceiling bracket	120	140
	11 153 43		

⑩		Length	Width
	Pendant splice	250	30
	11 153 11		

⑪		Height	Width
	Support jock	190	200
	11 166 32	190	300
	11 166 41	190	400
	11 166 50		

⑫		Length	Width
	Pendent rail	300	35
	11 153 27	500	35
	11 153 33	3000	35
	11 153 39		

⑬		Width	Placed
	Support jock	200	external
	11 152 25	300	external
	11 152 28	400	external
	11 152 31	500	external
	11 152 34	600	external
	11 152 37		

Fixed ceiling pendant/accessories

⑭		Side mounting
	Ceiling pendant	Length
	11 157 28	500
	11 157 32	750
	11 157 36	1000
		Placed
		side
		side
		side

⑮		Telecom channel/ divider
	Telecom channel	Width
	11 156 13	50
	11 156 24	100
		Model
		perforated
		perforated

⑯		Accessories – mounting
	Fastening screw	
	11 157 11	M8x16 [50 pcs/pack.]

⑰		Side mounting
	Ceiling pendant	Length
	11 157 04	300
	11 157 08	500
	11 157 12	1000
		Placed
		center
		center
		center

⑱		Height	Length
	Divider	25	2750
	11 184 80	40	2750
	11 184 81	–	joint
	11 184 73		

⑲		Universal bracket
	11 165 30	(int. bracket clamp)

⑳		End protection
	11 152 92	

㉑		Mounting plate
	11 155 87	Fits MP-Z4 and Z

㉒		Angle bracket
	11 153 85	Length 90
	11 153 81	Length 200

Cable ladders MP-FZ self supporting

Hot-dip galvanized 60 µm – corrosion class max C4

Note!

Angle bracket 11 153 90 is designed to better fit free-standing ladders and anchor rails.



Choosing right Cable ladder!

MP-FZ self supporting cable ladder is hot-dip galvanized with a coating of 60 µm. Manufactured and adapted for outdoor use, (corrosion class up to C4 – read more on page 2). The ladder is especially suitable for applications requiring long bracket spacings, both indoors and outdoors. Normal bracket spacing center-to-center is 6 meters. All accessories meet the corrosion class up to C4, unless otherwise stated. (Joint meets requirements for electrical continuity with a good margin.)

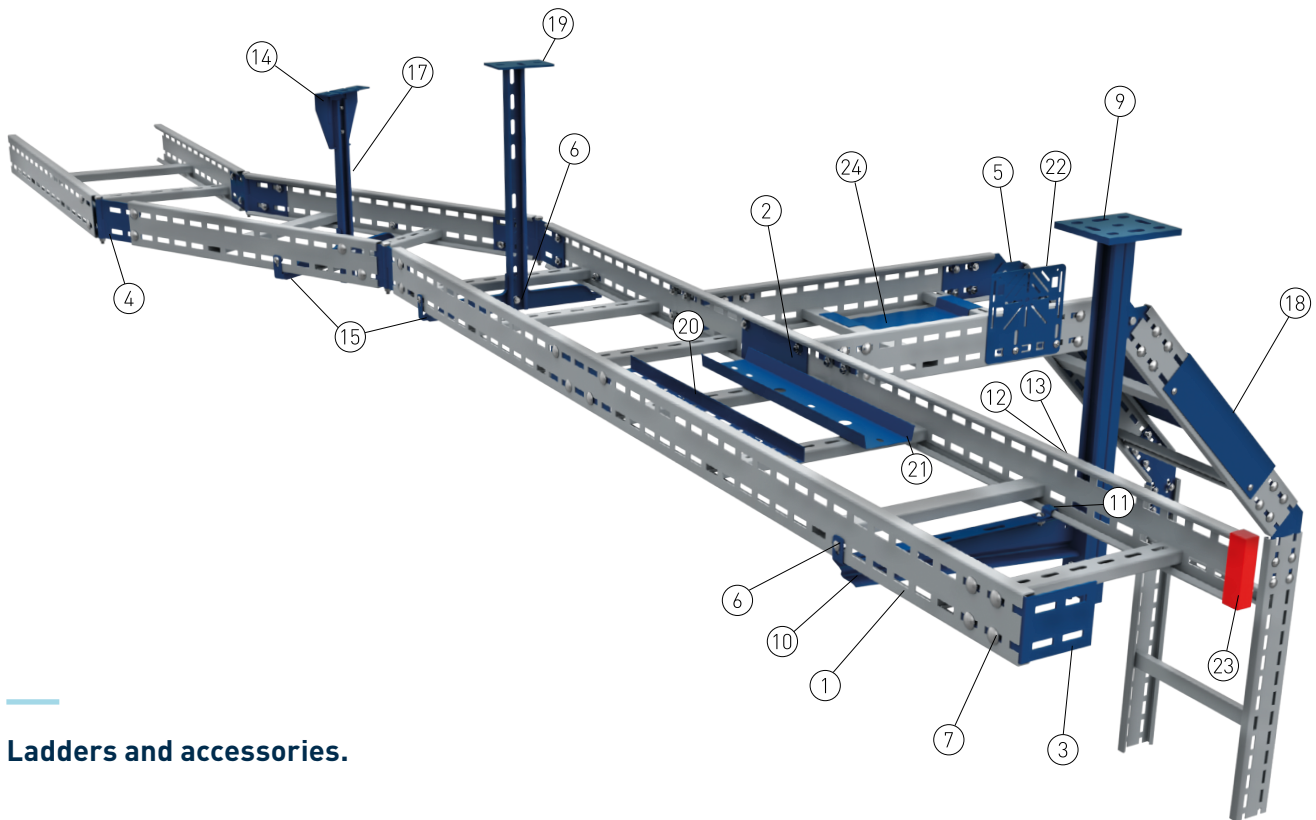

Ladders and accessories.

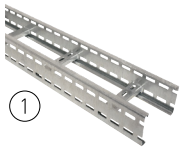

Ladder MP-FZ	Length	Width
11 150 85	6000	200
11 150 88	6000	300
11 150 91	6000	400
11 150 94	6000	500
11 150 97	6000	600

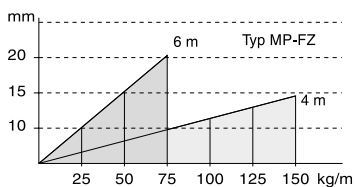

Cable ladders MP-FZ – self supporting



E-number – dim. (mm) – accessories

②  Assembled with bolts 11 155 85.
Splice
 11 153 67

③  Assembled with bolts 11 155 85.
Angle bracket
 11 153 88

④  Assembled with bolts 11 155 85.
Horizontal axis
 11 153 78

⑤  Assembled with bolts 11 155 85.
Vertical axis
 11 153 77

⑥  ⑦ 
Fastening screw /bolt
 11 156 80 M8x16 (50 pcs/pack.)
 11 155 85 M10x20 (50 pcs/pack.)

Fixed ceiling pendant – side mounting

⑨ 

Ceiling pendant	Length	Width
11 157 40	500	21x41
11 157 44	750	21x41
11 157 48	1000	21x41
11 157 52	1500	21x41
11 157 56	2000	21x41
11 157 60	3000	21x41

⑩ 

Cantilever arm	Width	Max. load kg
11 151 91	200	450
11 151 93	300	450
11 151 95	400	450
11 151 97	500	450
11 151 99	600	450

⑪  Assembled with bolts 11 156 80.
Cantilever arm clamp
 11 152 01 [10 pcs/pack.]

⑫ 
T-screw
 11 158 14
 Corr. class C4

⑬ 
Nut washer
 11 157 17
 Size M10x25
 Corr. class C4

Ceiling pendant – center mounting

⑭ 
Ceiling bracket
 11 153 43
 Height 120
 Corr. class C4

⑮ 

Support jock	Width	Corr. class
11 152 23	200	C2
11 152 25	200	C4
11 152 26	300	C2
11 152 28	300	C4
11 152 29	400	C2
11 152 31	400	C4
11 152 32	500	C2
11 152 34	500	C4
11 152 35	600	C2
11 152 37	600	C4

⑰  Assembled with bolts 11 156 80.

Mounting plate	Length	Width
11 153 97	200	200
11 153 99	300	300
11 154 01	400	400

⑰ 

Anchor rail	Length	Corr. class
11 158 39	250	C2
11 158 40	250	C4
11 158 47	500	C2
11 158 48	500	C4
11 158 02	3000	C2
11 158 00	3000	C4

Fixed ceiling pendant/accessories

⑲  Center mounting

Ceiling pendant	Length
11 157 28	500
11 157 32	750
11 157 36	1000

⑳  L 2750 mm.

Divider	Height	Corr. class
11 184 72	25	C2
11 184 80	25	C4
11 184 81	40	C4
11 184 73		C2

㉑ 

Angle bracket	Length	Height
11 153 85	90	30
11 153 90	90	42
11 153 81	200	30

㉒ 

Telecom channel	Width	Corr. class
11 156 00	50 unperf.	C2
11 156 04	100 unperf.	C2
11 156 13	50 perf.	C4
11 156 24	100 perf.	C4

㉓ 
Mounting plate
 11 155 79
 11 155 87
 Corr. class C2
 C4

㉔ 
End protection
 11 152 93

㉕ 
Luminaire plate
 11 155 71
 Corr. class C2

Cable ladders – stainless steel

Stainless – corrosion class max C5I

Choosing right Cable ladder!

Stainless steel cable ladders for environments with very high corrosivity. Normal bracket spacing center-to-center is 2 meters. Manufactured and adapted for outdoor use, (corrosion class up to C5I) – read more on page 2. (Joint meets requirements for electrical continuity with a good margin.)

Cable ladders in acid-resistant design - see the MP catalog!

Note!

In the MP range, there are also acid-resistant cable ladders approved for car and railway tunnels. Contact our sales representatives for further information - see page 28.

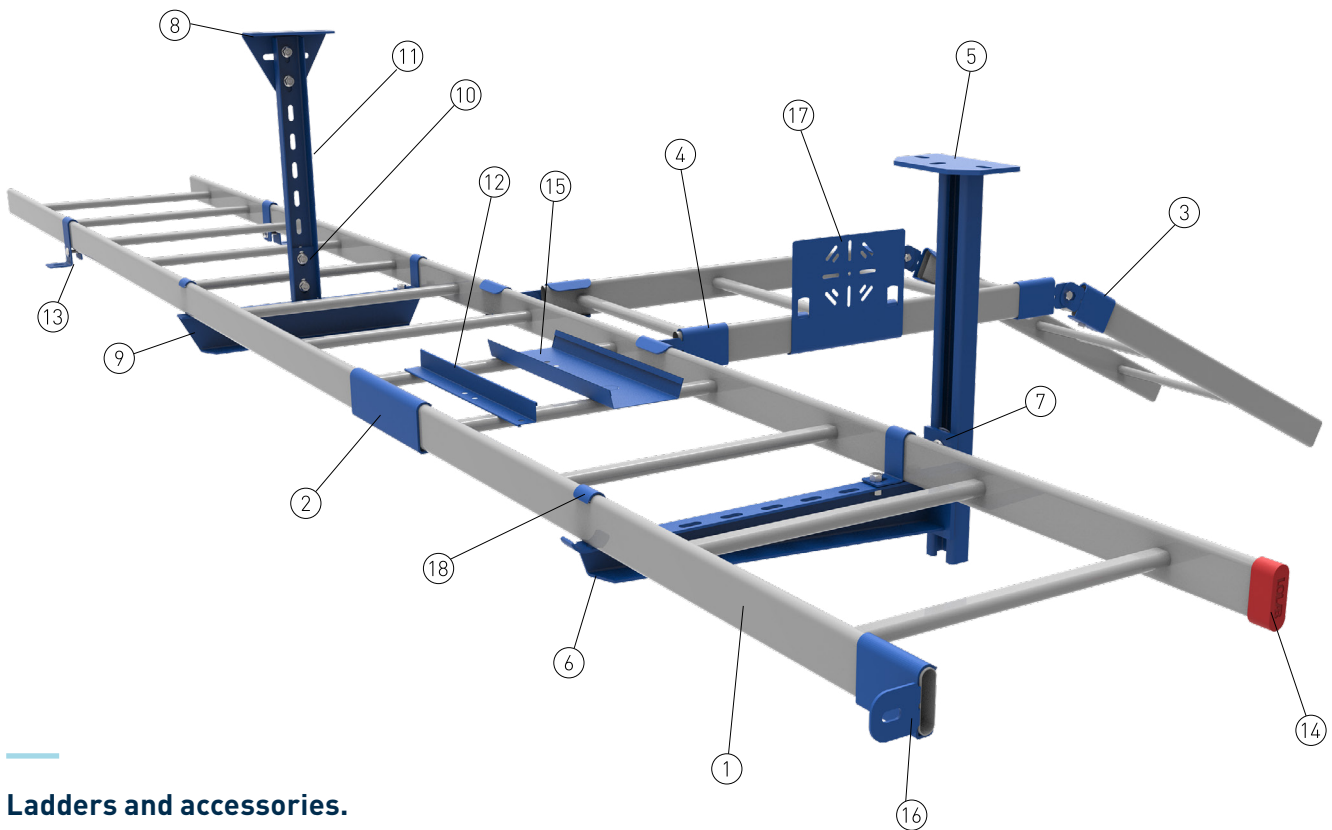

Ladders and accessories.



① Closed side

Stainless ladder	Length	Width
11 161 02	6000	200
11 161 04	6000	300
11 161 06	6000	400
11 161 08	6000	500
11 161 10	6000	600

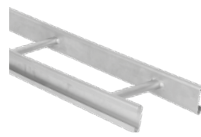

Open side

Stainless ladder	Length	Width
11 163 02	6000	200
11 163 04	6000	300
11 163 06	6000	400
11 163 08	6000	500
11 163 10	6000	600

Deflection in mm at bracket spacing 1,5-4 m.

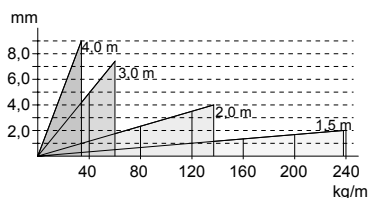

Deflection in mm at bracket spacing 2-4 m.

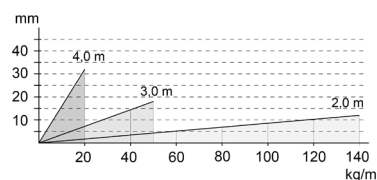

Cable ladders – stainless steel

E-number – dim. (mm) – accessories

②  **Splice**
11 161 88

Placed
external

③  **Vertical axis**
11 161 92

Placed
external

④  **Flat elbow**
11 161 94
11 161 96

Placed
external external
left right

Ceiling pendant – side mounting

⑤  **Ceiling pendant**
11 162 10
11 162 14
11 162 18

Length
280
505
1000

⑥  **Cantilever arm**
11 161 24
11 161 26
11 161 28
11 161 30
11 161 32

Width
200
300
400
500
600

⑦  **T-screw**
11 162 93

M8x30

Ceiling pendant – center mounting

⑧  **Ceiling pendant**
11 162 06

⑨  **Support joke**
11 161 36
11 161 38
11 161 40
11 161 42
11 161 44
11 161 46

Width
150
200
300
400
500
600

⑩  **Fastening screw**
11 162 90
11 162 91

M8x20
M8x30

⑪  **Pendant rail**
11 162 42
11 162 46
11 162 52

Length
325
505
2980

Accessories

⑫  **Divider**
11 162 74
11 162 76

Height
24
60

⑬  **Wall bracket**
11 161 98
11 162 00

Height
25
75

⑭  **End protection**
11 162 97

⑮  **Telecom**
11 162 78
11 162 80

Width
50
100

⑯  **Floor and end bracket**
11 162 02
11 162 04

Typ
left
right

⑰  **Mounting plate**
11 162 64

⑱  **Cantilever arm clamp**
11 161 48

Wire mesh trays

Electrogalvanized 10 µm/Z4 – corrosion class max C1/C4

Note!

The new Wire mesh tray in Z4 material can withstand environments up to C4 – at an even lower price.

Choosing right Wire mesh trays!

Wire mesh trays for both indoor and outdoor use – see page 2. Normal bracket spacing center-to-center is 2 meters. (Joint meets requirements for electrical continuity with a good margin.) Some accessories are specifically designed for C4 environments but are also suitable for lower corrosion classes, reducing the number of items/stock locations.

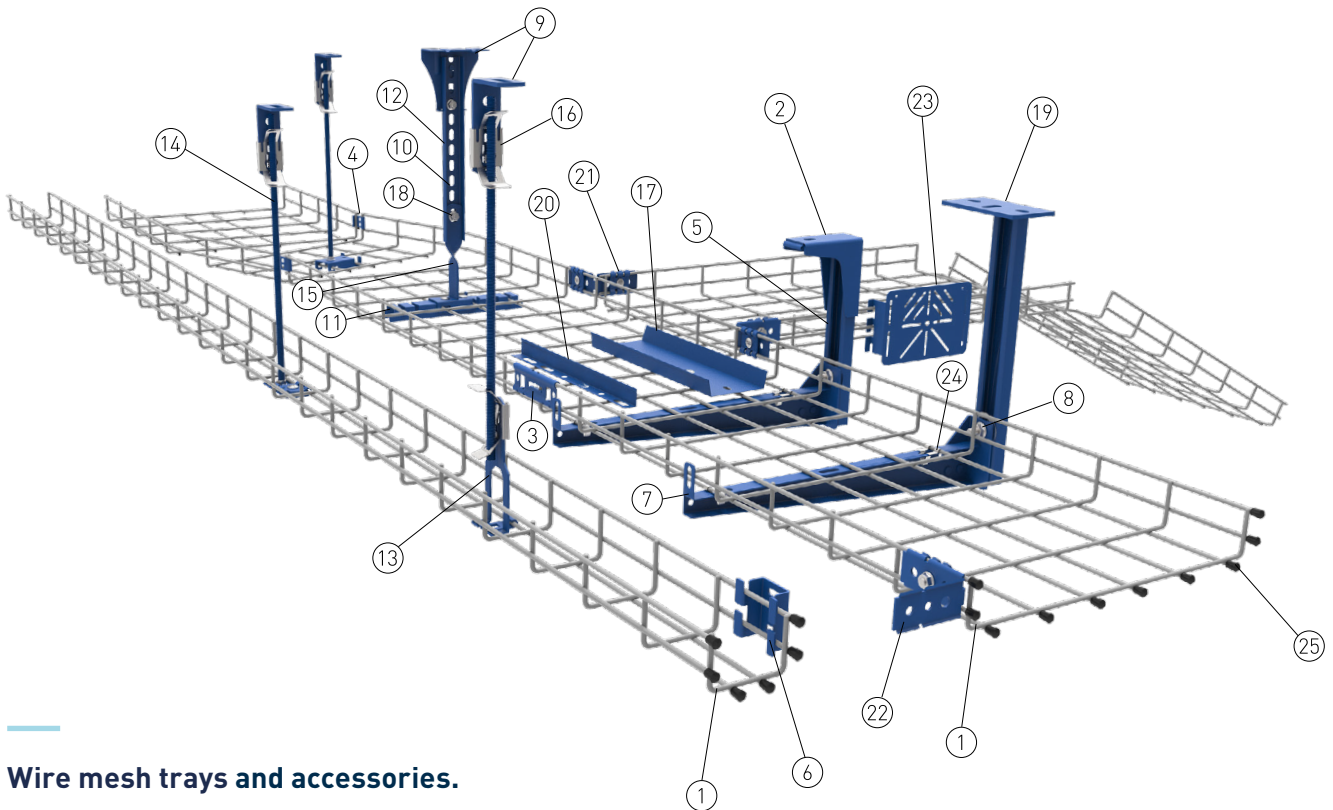

Wire mesh trays and accessories.

Corrosion class max C1

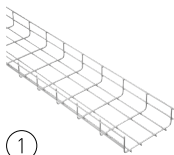

Wire mesh tray	Length	Width
11 163 91	2500	55
11 164 00	2500	75
11 164 09	2500	120
11 164 18	2500	200
11 164 27	2500	300
11 164 36	2500	400
11 164 45	2500	500
11 164 54	2500	600

Corrosion class max C4

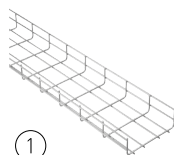

Wire mesh tray	Length	Width
11 163 95	2500	55
11 164 04	2500	75
11 164 16	2500	120
11 164 25	2500	200
11 164 34	2500	300
11 164 43	2500	400
11 164 52	2500	500
11 164 61	2500	600

Deflection in mm at bracket spacing 1,5 m.

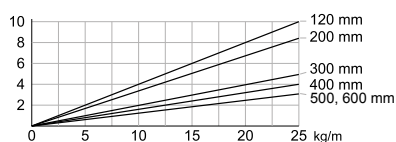

Deflection in mm at bracket spacing 2 m.

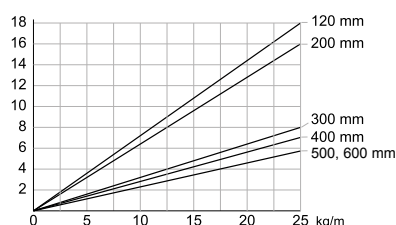

Note!

To make the installation of wire mesh tray on flat roofs easier, we have a roof support with E - no. 11 165 89, where the wire mesh tray can be easily clicked into place. Suitable for 120 mm or 200 mm width.



Wire mesh trays

E-number – dim. (mm) – accessories

Ceiling pendant – side mounting



Ceiling pendant	Height	Corr. class
11 157 97	104	C2
11 157 98	104	C4



Anchor rail	Width	Corr. class
11 158 39	250	C2
11 158 40	250	C4
11 158 47	500	C2
11 158 48	500	C4
11 158 02	3000	C2
11 158 00	3000	C4



T-screw	Size	Corr. class
11 158 22	M10x35	C1
11 158 15	M10x30	C4



Splice	Corr. class
11 165 10	C2
11 165 14	C4



Corner splice	Corr. class
11 165 20	C2
11 165 26	C5M



Cantilever arm	Width	Corr. class
11 165 43	120	C2
11 165 46	120	C4
11 165 52	200	C2
11 165 55	200	C4
11 165 61	300	C2
11 165 64	300	C4
11 165 70	400	C2
11 165 73	400	C4
11 165 74	500	C2
11 165 78	500	C4
11 165 80	600	C2
11 165 84	600	C4



Wall bracket	For width	Corr. class
11 165 85	55-75	C2
11 165 87	55-75	C4
11 166 03	75-120	C2
11 166 06	75-120	C4

Ceiling pendant – center mounting



Ceiling pendant	Height	Corr. class
11 153 46	100	C2
11 153 47	100	C4
11 153 85	90	C4

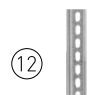

Pendant rail	Length	Corr. class
11 153 26	300	C2
11 153 27	300	C4
11 153 32	500	C2
11 153 33	500	C4
11 153 38	3000	C2
11 153 39	3000	C4



Pendent splice	Length	Corr. class
11 153 11	250	C4



Support yoke	Fits	Corr. class
11 166 57	55-75	C4



Support yoke	Fits	Corr. class
11 166 63	120-600	C1
11 166 67	120-600	C4



Support for yoke	For width	Corr. class
11 166 70	300-400	C1
11 166 74	300-400	C4
11 166 71	500-600	C1
11 166 75	500-600	C4



Threaded rod	Length	Corr. class
11 175 57	3000	C1



Threaded rod bracket	Width	Corr. class
11 175 01	200	C1

Fixed ceiling pendant/accessories



Center mounting.

Ceiling pendant	Length	Corr. class
11 157 04	300	C4
11 157 08	500	C4
11 157 12	1000	C4



Side mounting.

Ceiling pendant	Length	Corr. class
11 157 28	500	C4
11 157 32	750	C4
11 157 36	1000	C4



Assembled with a universal bracket and screw.

Angle bracket	Corr. class
11 165 38	C2
11 165 40	C4

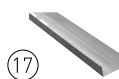

Telecom channel.

Telecom channel	Width	Corr. class
11 156 00	50 unperf.	C2
11 156 04	100 unperf.	C2
11 156 12	50 perf.	C2
11 156 13	50 perf.	C4
11 156 16	100 perf.	C2
11 156 24	100 perf.	C4



Divider 2750 mm.

Divider	Height	Corr. class
11 184 72	25	C2
11 184 80	25	C4
11 184 81	40	C4
11 184 73	-	splice



Mounting plate	Corr. class
11 166 18	C2
11 166 22	C4



Accessories – mounting.

Fastening screw	Corr. class
11 157 11 M8x16 (50 pcs/pack)	C1
11 156 80 M8x16 (50 pcs/pack)	C4



Universal bracket	Corr. class
11 165 30	C2
11 165 34	C4



Cantilever arm clip	Corr. class
11 165 83	C5M



Plastic cap	Fits wire mesh trays width
11 167 03	55-75 mm
11 167 06	120-300 mm
11 167 09	400-600 mm

Luminaire rails/cable trays

Sendzimir and White painted – corrosion class max C1 – C4

Choosing right luminaire rails/cable trays!

Luminaire rails and cable trays for indoor use. The 75 mm luminaire rails is available in Z4 (Part No. 11 170 63) for outdoor use – see page 2.

The splice come with built-in support for faster and easier installation and meet the requirements for electrical continuity with a good margin. Splices in 55 mm and 75 mm width have built-in friction locks. The calculated bracket spacing is determined by the length of the track – a two-meter track has a bracket spacing of 2 m, and a three-meter track has a 3 m bracket spacing. A six-meter luminaire rails requires a support in the middle. These apply under normal load.

Sendzimir is a corrosion protection, and variations in shade/appearance may occur.

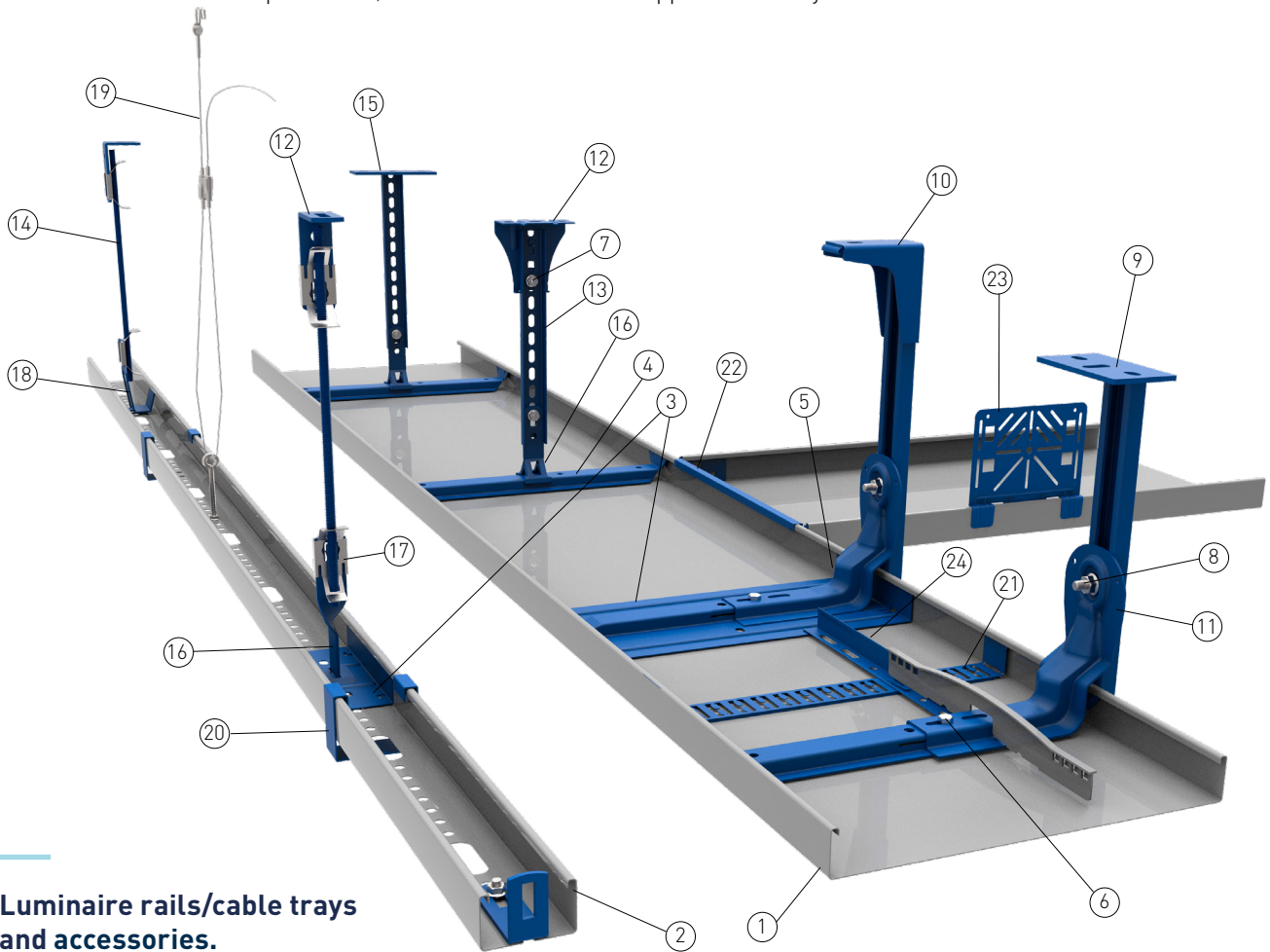

Luminaire rails/cable trays and accessories.



①	Cable trays sendz.	Length	Width
11 170 18	3000	100	
11 170 24	3000	200	
11 170 30	2000	300	
11 170 34	2000	400	
11 170 40	2000	600	



①	Cable trays white	Length	Width
11 170 19	3000	100	
11 170 25	3000	200	
11 170 31	2000	300	
11 170 35	2000	400	
11 170 41	2000	600	



②	Luminaire rail sendz.	Length	Width
11 170 55	3000	50	
11 170 61	3000	75	
11 170 59	6000	75	
11 170 65	3000	100	
Luminaire rail white		Length	Width
11 170 56	3000	50	
11 170 62	3000	75	
11 170 66	3000	100	
Luminaire rail Z4		Length	Width
11 170 63	3000	75	

Luminaire rails/cable trays

E-number – dim. (mm) – accessories



③ Splice	Width	Corr.class
11 176 10	50	C2
11 175 97	75	C2
11 175 98	75	C4
11 176 01	100	C2
11 176 07	200	C2
11 176 13	300	C2
11 176 15	400	C2
11 176 21	600	C2



④ Support joke	Width	Corr.class
11 174 51	50	C2
11 174 53	75	C2
11 174 54	75	C4
11 174 55	100	C2
11 174 63	200	C2
11 174 67	300	C2
11 174 71	400	C2
11 174 79	600	C2

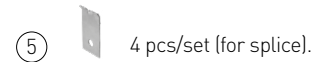

⑤ Lock clips	Fits
11 176 40	100-600



⑥ Fastening screw	Corr.class
11 157 13	- C1
11 157 11	50 pcs/pack. C1
11 156 80	50 pcs/pack. C4
11 158 22 (T-screw)	- C1

Ceiling pendant – side mounting



⑨ Ceiling pendant	Length	Corr.class
11 157 28	500	C4
11 157 32	750	C4
11 157 36	1000	C4



⑩ Anchor rail/ Ceiling bracket	Length	Corr.class
11 158 02	3000	C2
11 158 01 (white)	3000	C1
11 157 97	-	C2
11 157 96 (white)	-	C1



⑪ Cantilever arm	Width	Corr.class
11 172 05	100-200	C2
11 172 06 (white)	100-200	C1
11 172 09	300-600	C2
11 172 10 (white)	300-600	C1



⑫ Ceiling bracket	Height	Corr.class
11 153 46	100	C2
11 153 48 (white)	100	C1
11 153 85	90	C4
11 153 86 (white)	90	C1



⑬ Pendant rail	Length	Corr.class
11 153 38	3000	C2
11 153 40 (white)	3000	C1
11 153 39	3000	C4



⑭ Threaded rod	Length	Corr.class
11 175 55	2000	C1
11 175 56 (white)	2000	C1
11 175 57	3000	C1
11 175 58 (white)	3000	C1

Ceiling pendant – center mounting



⑮ Ceiling pendant	Length	Corr.class
11 157 04	300	C4
11 157 08	500	C4
11 157 12	1000	C4



⑯ Pendant bracket	Fits	Corr.class
11 173 91	50-75	C1
11 173 92 (white)	50-75	C1
11 173 93	50-75	C4
11 173 87	100-600	C2
11 173 88 (white)	100-600	C1



⑰ Threaded rod bracket	Width	Corr. clas
11 175 01	75	C1
11 175 02 (white)	75	C1



⑱ Wirependant	Model	Length
11 185 33	with quick lock	3000
11 185 36	with hook	3000
11 185 37	with hook	5000
11 174 11	eyebolt	M6x80



⑲ Support joke	Fits	Corr.class
11 173 99	75	C2
11 174 00 (white)	75	C1

Accessories



⑳ Luminaire bracket	Width	Corr.class
11 184 33	50	C2
11 184 34 (white)	50	C1
11 184 37	75	C2
11 184 38 (white)	75	C1
11 184 39	100	C2
11 184 40 (white)	100	C1



㉑ Tie support	Width	Corr.class
11 185 40	100	C2
11 185 44	200	C2
11 185 46	300	C2
11 185 48	400	C2
11 185 52	600	C2



㉒ End hook	Width	Placed
11 178 65	50	internal
11 178 68	75	internal
11 178 71	100	internal
11 178 77	200	internal
11 178 79	400	internal
11 178 93	600	internal



㉓ Mounting plate	Type	Corr.class
11 183 80	unperf.	C2
11 183 84 (white)	perf.	C1
11 183 85	perf.	C4
11 184 02	perf.	C2
11 184 03 (white)	perf.	C1

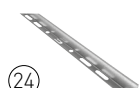

㉔ Divider	Height	Length
11 184 70	25	1750
11 184 72	25	2750
11 184 73	-	splice

Wall trunkings – Ductel 3 m

Aluminum wall trunking – white RAL9010/ black RAL9005

The wall trunkings are made of aluminum with a 45 mm or 80 mm opening. When mounted with a wall bracket, the normal bracket spacing is typically calculated at 1 m center-to-center. Joints meet the requirements for electrical continuity with a good margin. All channels have a perforated back.

Note!

All corners fit both interior and exterior, and most accessories in our wall trunking systems are common – faster and easier! Switches and additional outlets – see page 27. Calculate window sill channels entirely according to your own preferences using the MP configurator.

<https://konfigurator.mpbolagen.se>



Wall trunkings and accessories.

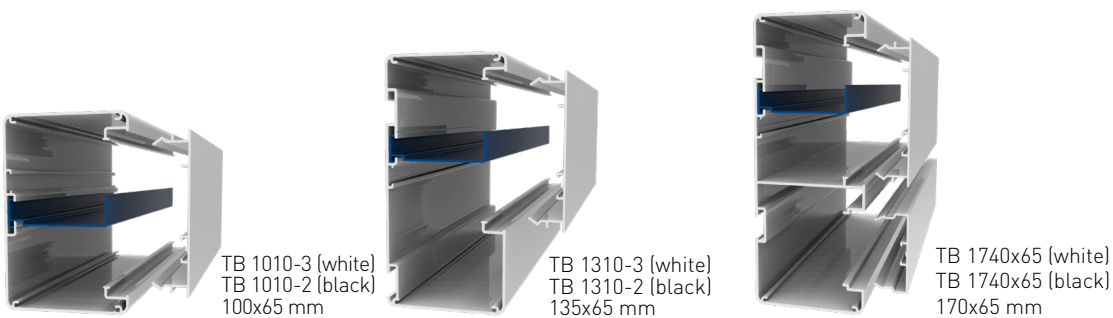

	E-no white	E-no black	E-no white	E-no black	E-no white	E-no black	Length
Profil	11 793 51	11 782 23	11 793 55	11 782 24	11 793 61	11 782 27	3 000
Front 45 mm	–	–	–	–	11 793 71	11 782 28	3 000
Front 80 mm	11 793 73	11 782 29	11 793 73	11 782 29	11 793 73	11 782 29	3 000



Splice TBJ

	E-no	Dim. mm	E-no	Dim. mm	E-no	Dim. mm
Splice	11 793 96	53x12x70	11 793 96	53x12x70	11 793 96	53x12x70

Wall trunkings – Ductel

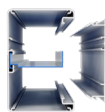

TB 1010-3 (white)
TB 1010-2 (black)
100x65 mm

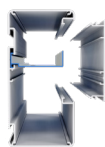

TB 1310-3 (white)
TB 1310-2 (black)
135x65 mm

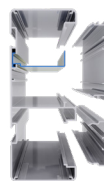

TB 1740-3 (white)
TB 1740-2 (black)
170x65 mm



End plate

E-no	Dim. mm	E-no	Dim. mm	E-no	Dim. mm
11 793 89 (white)	100x65x24	11 793 91 (white)	135x65x24	11 793 93 (white)	135x65x24
11 782 44 (black)	100x65x24	11 782 45 (black)	135x65x24	11 782 47 (black)	170x65x24



Corner

E-no	Height	E-no	Height	E-no	Height
11 793 84 (white)	100	11 793 85 (white)	135	11 793 86 (white)	170
11 782 30 (black)	100	11 782 33 (black)	135	11 782 34 (black)	170



Decor splice

E-no	Dim.	E-no	Dim.	E-no	Dim.
11 788 81 (white)	65x30x100	11 788 83 (white)	65x30x135	11 788 85 (white)	65x30x170
11 782 39 (black)	65x30x100	11 782 42 (black)	65x30x135	11 782 43 (black)	65x30x170

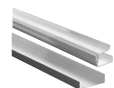

1- Intermediate shelf
1- Intermediate shelf

E-no		E-no		E-no	Length
11 788 14	-	11 788 14	-	11 788 14	1 000
11 788 15	-	11 788 15	-	11 788 15	1 000



Cantilever arm 25
Cantilever arm 50
Cantilever arm 100

E-no		E-no		E-no	
-	-	11 788 05	-	11 788 05	-
-	-	11 788 06	-	11 788 06	-
-	-	11 788 07	-	11 788 07	-



Ventilation grille-
3-pack
Joint 10-pack

E-no white	E-no black	E-no white	E-no black	E-no white	E-no black	Dim.
-	-	11 788 19	11 782 35	11 788 19	11 782 35	3 000
-	-	11 788 21	11 788 21	11 788 21	11 788 21	73x40
-	-	11 788 25	11 788 25	11 788 25	11 788 25	50x10

Outlet and universal box
for switches, etc.



	E-no white	E-no black	E-no white	E-no black	E-no white	E-no black	Dim.
Earthing clamp	11 788 22	11 788 22	11 788 22	11 788 22	11 788 22	11 788 22	-
2-way socket outlet	11 792 71	11 782 48	11 792 71	11 782 48	11 792 71	11 782 48	85x50x180
2-way socket outlet DATA	11 792 75	-	11 792 75	-	11 792 75	-	85x50x180
4-way socket outlet	11 792 73	11 782 49	11 792 73	11 782 49	11 792 73	11 782 49	85x50x250
4-way socket outlet DATA	11 792 77	-	11 792 77	-	11 792 77	-	85x50x250
Universal box 1	11 788 42	11 788 42	11 788 42	11 788 42	11 788 42	11 788 42	79x42,5x79
Universal box 2	11 788 43	11 788 43	11 788 43	11 788 43	11 788 43	11 788 43	79x42,5x150

Cover with mounting frames for data
jacks in the most common formats.



	E-no white	E-no black	E-no white	E-no black	E-no white	E-no black	Dim.
DUCT 2xKeystone	11 792 82	11 782 51	11 792 82	11 782 51	11 792 82	11 782 51	85x50x90
DUCT 2xAmp	11 792 83	-	11 792 83	-	11 792 83	-	85x50x90
DUCT 2xSystemax	11 792 84	-	11 792 84	-	11 792 84	-	85x50x90
DUCT 2xActassi	11 792 85	11 782 50	11 792 85	11 782 50	11 792 85	11 782 50	85x50x90

Track lightning- Global Trac

Choice of track lightning!

Available in four different lengths in white, black, and gray finishes for both recessed and surface-mounted installation, but in the quick guide, we show surface-mounted. Recommended pendant distance is center-to-center 1 meter, with a minimum height of 2.2 meters. If the track is placed in enclosed spaces, such as a closed display window, it may be positioned lower - however, a minimum of 50 mm above the floor. The Pulse version has the same features as the Pro version but with the ability to handle Dali - 0-10 V, etc.



Global track - PRO

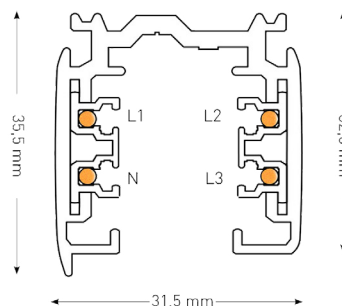

L mm	E-no grey	E-no black	E-no white
1000	74 001 69	74 003 81	74 001 68
2000	74 001 67	74 002 92	74 001 66
3000	74 001 65	74 002 93	74 001 64
4000	74 001 63	74 002 94	74 001 62

Global track - PULSE

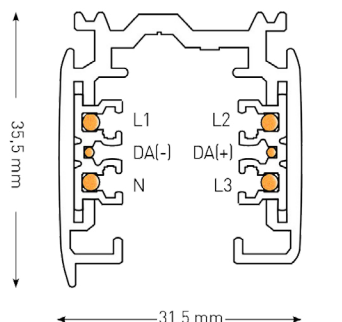

L mm	E-no grey	E-no black	E-no white
1000	74 030 15	74 003 86	74 003 87
2000	74 030 19	74 003 88	74 003 89
3000	74 030 22	74 003 90	74 003 91
4000	74 030 30	74 003 92	74 003 93

Track lightning– Global Trac

Keep in mind!

Red line on connectors indicates polarity ridge.



Straight connector

Model	E-no grey	E-no black	E-no white
Pro	74 001 93	74 003 73	74 001 92
Pulse	74 030 20	74 004 00	74 004 01



Middle feed

Model	E-no grey	E-no black	E-no white
Pro	74 001 95	74 003 72	74 001 94
Pulse	74 030 18	74 003 98	74 003 99



Flexible corner connector - PRO

E-nr grey	E-nr black	E-nr white
74 001 89	74 003 74	74 001 88



End cap

E-no grey	E-no black	E-no white
74 001 73	74 002 91	74 001 72



End feed - PRO

Model	E-no grey	E-no black	E-no white
XTS 11	74 001 99	74 002 89	74 001 98
XTS 12	74 001 97	74 002 96	74 001 96



End feed - PULSE

Model	E-no grey	E-no black	E-no white
XTSC 611	74 030 16	74 003 94	74 003 95
XTSC 612	74 030 17	74 003 96	74 003 97



L - feed - PRO

Model	E-no grey	E-no black	E-no white
XTS 34	74 001 87	74 002 98	74 001 86
XTS 35	74 001 85	74 003 75	74 001 84

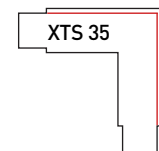
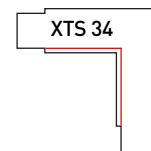

L - feed - PULSE

Model	E-no grey	E-no black	E-no white
XTSC 634	74 030 23	74 004 04	74 004 05
XTSC 635	74 030 24	74 004 06	74 004 07

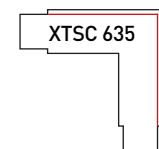
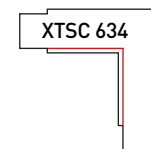

T - feed - PRO

Model	E-no grey	E-no black	E-no white
XTS 36	74 001 83	74 003 76	74 001 82
XTS 37	74 001 81	74 003 77	74 001 80
XTS 39	74 001 77	74 003 79	74 001 76
XTS 40	74 001 75	74 003 80	74 001 74

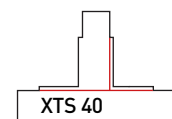
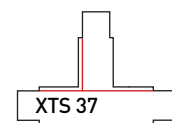

Track lightning- Global Trac



T - feed - PULSE

Model	E-no grey	E-no black	E-no white
XTSC 636	74 030 25	74 004 08	74 004 09
XTSC 637	74 030 26	74 004 10	74 004 11
XTSC 639	74 030 28	74 004 12	74 004 13
XTSC 640	74 030 29	74 004 14	74 004 15

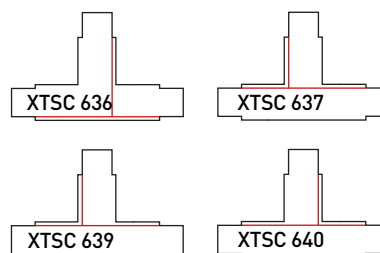

X - feed - PRO

Model	E-no grey	E-no black	E-no white
XTS 38	74 001 79	74 003 78	74 001 78

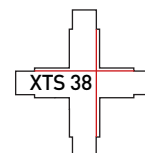

X - feed - PULSE

Model	E-no grey	E-no black	E-no white
XTSC 638	74 030 27	74 004 16	74 004 17

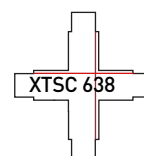

Wire suspension

L mm	E-no grey	E-no black	E-no white
1500	74 031 00	74 031 03	74 031 06
3000	74 031 01	74 031 04	74 031 07
5000	74 031 02	74 031 05	74 031 08



Clip for T-bar

E-no grey	E-no black	E-no white
74 002 33	74 004 19	74 002 34



Clam for Rod and Wire

E-no grey	E-no black	E-no white
74 002 12	74 003 29	74 002 11



Slot connection - PRO, 10 A

E-no grey	E-no black	E-no white
74 002 44	74 002 95	74 002 01



Multiadapter - PULSE, 10 A

E-no grey	E-no black	E-no white
74 031 48	74 004 21	74 004 22



Nipples for adapters

E-no grey	E-no black	E-no white
74 031 50	74 004 24	74 004 25



Hook suspension - 2 mm

E-no grey	E-no black	E-no white
74 031 51	74 031 52	74 002 05



Hook - 2 mm

E-no
74 002 06



Slot connection tool

E-no
74 004 23



Bending tool

E-no
74 002 13

Service poles – Posts

Standard poles – selection from the standard range.

MP bolagen are the complete supplier of cable installation for electrical and data purposes in buildings. The final distribution to the end-user takes place through MP service poles.

Our goal is to develop the various components into the industry's most functional and integrated systems.

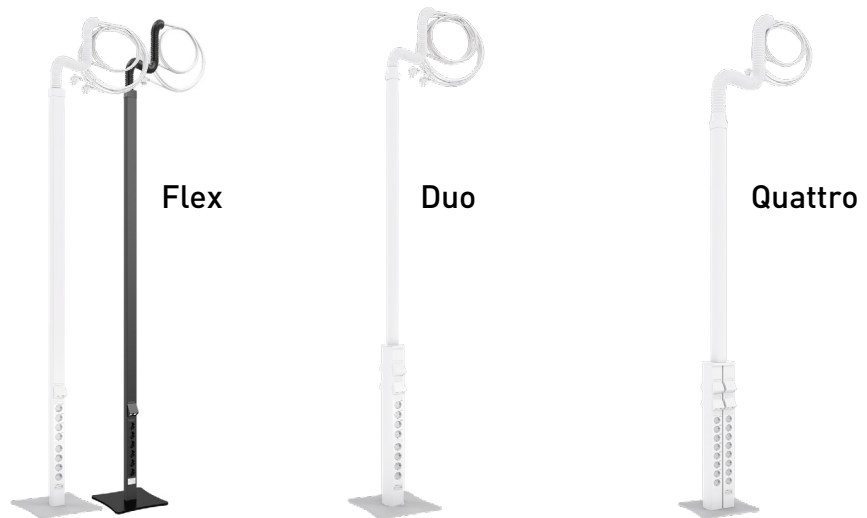

Model	MP-U500 V	MP-U500 SV	MP-U501 V	MP-U601 V	MP-U602 V	MP-U701 V
E-no	11 744 88	11 782 03	11 790 01	11 790 11	11 790 14	11 790 18
Length	2100	2100	2100	2100	2100	2100
Tube	2000	2000	2000	2000	2000	2000
General power	6 sockets	6 sockets	4 sockets	8 sockets	8 sockets	16 sockets
Data power	–	–	4 sockets	8 sockets	8 sockets	16 sockets
RJ45	2 pcs.	2 pcs.	2 pcs.	4 pcs.	8 pcs.	8 pcs.
Blind cover	–	–	1 pcs.	2 pcs.	–	4 pcs.
Tot. cable length	7500	7500	7500	7500	7500	7500
Pole base, 8 kg	11 791 20	11 782 13	11 791 20	11 791 20	11 791 20	11 791 20
Design base 12,5 kg	11 791 74	11 783 94	11 791 74	11 791 74	11 791 74	11 791 74
Ceiling frame	11 791 86	11 791 86	11 791 86	11 791 86	11 791 86	11 791 86
Wall bracket	11 791 31	11 783 99	11 791 31	–	–	–

Mobile post, service post och suspended box

A close collaboration with customers and responsive sales representatives forms the foundation for these models.



Model	MP-U615 V	MP-U616 V	MP-U610 V
E-no	11 790 16	11 790 19	11 790 15
Length	530 mm	476	370
Tube	–	–	–
General power	8 sockets	6 sockets	4 sockets
Data power	–	–	–
RJ45	–	–	–
Blind cover	2 pcs.	2 pcs.	–
Tot. cable length	ca 4,7 m	–	500-3000
HDMI	–	1 pcs.	–
USB-socket	–	1 pcs.	–
Balance block	–	–	11 792 58
Balance block	–	–	11 792 59

MP-configurator

Design an service pole
- faster and easier!

The MP Configurator is easy to use, allowing you to design an service pole entirely according to your own preferences.



If you want to know more, contact us - see page 28.

<https://konfigurator.mpbolagen.se>

Floor boxes – PUK

Square installation units filling depth 8-12 mm - minimum height 65-110 mm. Built-in dimensions 261x261 mm. See page 24 for a device box with a low build depth (65 mm), suitable for 11 790 54. Maximum load 150 kg.

Stainless with carpet flange
11 790 60

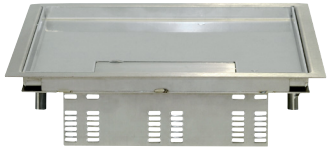

Plastic with carpet flange
11 790 54

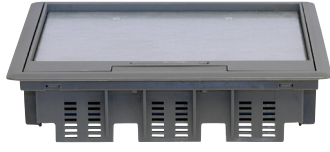

Component example

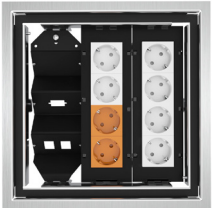

Dim. -angled/straight plug.





Component example

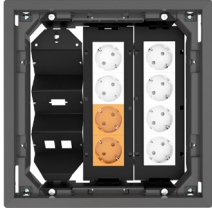

Dim. -angled/straight plug.



Moulding piece, rectangular floor boxes
11 790 43 height 150 mm

Junktion box – 400x400 mm
11 790 36
Min. built-in height 87 mm.

Rectangular installation units for dry-cleaned floors with space for 8 units. Filling depth 8-12 mm - minimum height 65-110 mm. Built-in dimensions 261x186 mm. Maximum load 150 kg.

Stainless with carpet flange
11 790 59



Plastic with carpet flange
11 790 52



Component example



Dim. -angled/straight plug.





Component example



Dim. -angled/straight plug.



Moulding piece
11 790 42 height 150 mm

Junktion box – 400x400 mm
11 790 34
Min. built-in height 87 mm.

Floor boxes – PUK

Round installation units in plastic with a carpet flange, for dry-cleaned floors and space for 12 units. Filling depth 8 mm - minimum height 65 mm. Built-in dimensions Ø 307 mm. Maximum load 150 kg.

Installation unit – round
11 790 56



Component example

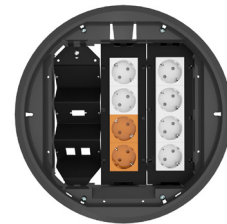

Moulding pipe
11 790 44 height 150 mm



Junction box – 450 x450 mm
11 790 39
Min. built-in height 87 mm.

Dim. –angled/straight plug.



Round installation units – Bodo in plastic and aluminum with a 230V socket and Cat6 STP data outlet - minimum height 87-102 mm. Built-in dimensions Ø 122 mm.

Bodo N: 1x230, 1xRJ45 (IP66). Max.load 1500 kg.

Bodo N4: 2x230, (IP66). Max.load 1500 kg.

Bodo T-G: 1x230, 1x blind. Max.load 150 kg.

Bodo N – aluminum
11 790 50

Bodo N4 – aluminum
11 770 13

Bodo T-G – plastic
11 790 51

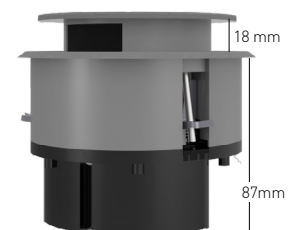
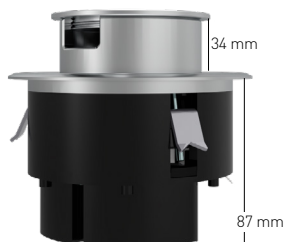

Moulding pipe
11 790 40 height 150 mm

Junction box – 160x160 mm
11 790 31
Min. built-in height 73 mm



Floor boxes – PUK

Electricity and data

Mounting box – 4 socket units
11 790 72



Assembly frame – mounting box
11 790 73



230 V-socket outlet
11 790 80 1-way white
11 790 81 1-way orange



230 V-socket outlet
11 790 82 2-way white
11 790 83 2-way orange



230 V-socket outlet
11 790 84 4-way white



Angled front cover – 45x45 mm
11 770 48 for data jacks
2 x keystone.



Assembly frame – data/media
11 790 86



Mounting plate – blind
11 790 87



Mounting plate – AMP SL
11 790 92

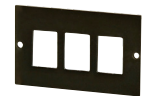

Mounting plate – Keystone
11 790 88



Mounting plate – Lexcom/Actassi
11 790 89



Mounting plate – XLR
11 790 90

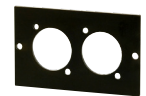

Mounting plate – D-sub/VGA
11 790 91



Other accessories

Mounting box – low inset depth
11 790 74 for plastic installation unit
(11 790 54).
Fits 8 units for mounting in frame
11 790 54.

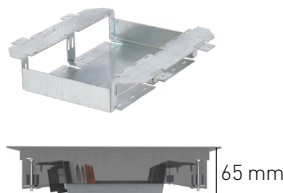

Assembly frame
11 790 75 for mounting general
power and data outlets, (fits the
device box above)



For additional solutions or combinations, please
contact our sales team at,
0383-76 36 00 or offert@mpbolagen.se

Mounting plate – 22,5x45 mm
1xKeystone
11 770 47



Blind cover – 22,5x45 mm
11 790 78



Blind cover – 45x45 mm
11 790 79



USB 3,0 – Keystone
11 792 50



HDMI – Keystone
11 792 51



PHONO 3,5 mm – Keystone
11 792 52



19"-racks

MP-telecom/data racks is mounting kits

assembly kits according to SS IEC 297 for 19" standard = 465 mm center distance between the upright profiles. The assembly is simple and done with screws and nuts. Accessories for the racks are available in several different variants. The racks are available in white painted and galvanized finish with a thickness of 10 µm. The front side has holes for cage nuts M6, and the rear side has holes of 6.5 x 31.75 mm for M6 screws and nuts.

Racks are also available in white painted finish
– see MP catalog.

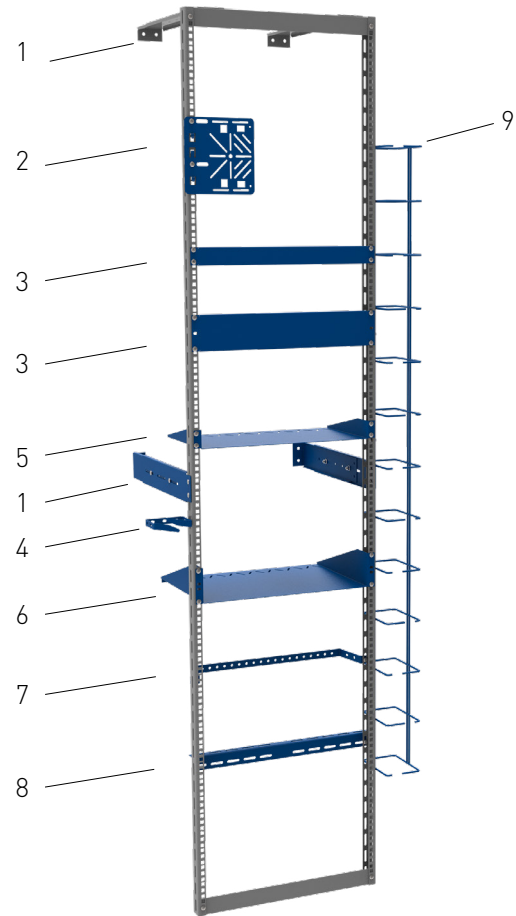
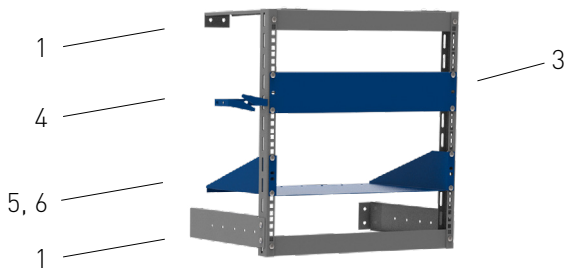

Wall rack

Article	E-no	Dim. mm
Wall rack	50 021 45	270
Wall rack	50 021 48	350
-		
-		

Accessories	E-no	Dim. mm
1 Flat bar	50 021 36	270
1 Flat bar	50 021 40	350
-		
-		
2 Mounting plate	11 155 79	
3 Blind plate	50 021 10	44
3 Blind plate	50 021 13	88
3 Blind plate	50 020 73	148
4 Wire guide bracket	50 020 43	
5 Shelf 1U	50 020 31	1U
6 Shelf 2U	50 020 34	2U
7 Cable support	50 020 86	
Cage nut M6 (20 pcs)	50 021 42	
Screw with nut M6x12 (20 pcs)	50 021 58	
Screw with nut M6x12 (100 pcs)	50 021 59	
-		
-		

Floor rack

Article	E-no	Dim. mm
Data rack	50 021 30	270
Data rack	50 021 32	350
Data rack	50 021 34	540
Data rack	50 021 23	350-600
Data rack – dividable	50 021 19	350-600

Accessories	E-no	Dim. mm
1 Flat bar	50 021 36	270
1 Flat bar	50 021 40	350
1 Flat bar	50 021 38	540
1 Flat bar – adjustable	50 021 25	350-600
2 Mounting plate	11 155 79	
3 Blind plate	50 021 10	44
3 Blind plate	50 021 13	88
3 Blind plate	50 020 73	148
4 Wire guide bracket	50 020 43	
5 Shelf 1U	50 020 31	1U
6 Shelf 2U	50 020 34	2U
7 Cable support	50 020 86	
8 Mounting rail	50 020 53	
Cage nut M6 (20 pcs)	50 021 42	
Screw with nut M6x12 (20 pcs)	50 021 58	
Screw with nut M6x12 (100 pcs)	50 021 59	
9 Wire guide	50 021 16	1600

Profile/assembly accessories

Mecanofunction on angle profile!



Assembly profile 2 m	Width	Corr.class
11 160 26	50	C2
11 160 25	50	C4
11 160 30	75	C2
11 160 29	75	C4
11 160 34	100	C2
11 160 33	100	C4
11 160 38	150	C2
11 160 37	150	C4
11 160 42	200	C2
11 160 41	200	C4
11 160 46	300	C2
11 160 45	300	C4
11 160 50	400	C2
11 160 49	400	C4



Angle profile	Length	Corr.class
26 844 42	3000	C2
26 844 44	3000	C4



Anchor rail	Length	Corr.class
11 158 02	3000	C2
11 158 00	3000	C4



Angle profile	Length	Corr.class
26 844 12	3000	C2
26 844 14	3000	C4



Anchor rail	Length	Corr.class
11 158 05	3000	C2
11 158 04	3000	C4

Mounting on the wall

Strapping profile for clamping on the wall.



Strapping profile	Length	Corr.class
11 160 00	2500	C4
11 160 01	2500	C4
11 160 12	2500	C2
11 160 13	2500	C2

Wall rail for mounting wall brackets, etc., on sandwich elements or concrete blocks.



Mounting with cantilever arm.

Wall rail	Length/width	Corr.class
11 158 58	700/121	C2
11 158 59	700/121	C4

Note!

Strapping profile for outdoor use are now also available in Z4. E-no 11 160 01 has the same high corrosion resistance class as hot-dip galvanized but is more environmentally friendly and also at a lower cost.

Nut – T-screw- och fastening screw



Nut washer	Dim/height	Corr.class
11 157 14	M8x20/21	C4
11 157 15	M8x20/41	C4
11 157 16	M10x20/21	C4
11 157 17	M10x25/21	C4
11 157 18	M10x25/41	C4



Fits 21- och 41 mm:s anchor rail.

T-screw	Dim.	Corr.class
11 158 20	M8x25	C1
11 158 22	M10x35	C1



T-screw	Dim/height	Corr.class
11 158 14	M10x30/21	C4
11 158 15	M10x30/41	C4



Fastening screw	Corr. class
11 157 11	M8x16 (50 pcs/pack.) C1
11 156 80	M8x16 (50 pcs/pack.) C4

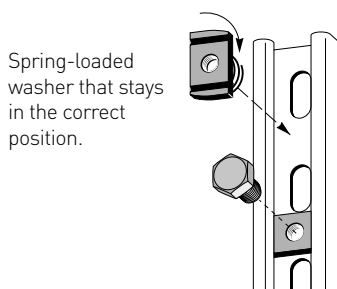

Spring-loaded washer that stays in the correct position.

1. Place T-screw in the rail opening.
2. Push the screw in.
3. Rotate the screw into place..



ABB low-voltage products

Reference to ABB E-no at the electrical wholesaler.

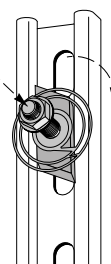

Jussi

AUD 20 junction box ProDuct
AUD 31 end package

E-no
11 746 04
11 746 07



Switch Stairs/1-pole

E-no
*18 150 22



Switch crown

E-no
*18 150 17



Pushbutton spri. return 1-pole

E-no
*18 150 47



2-pole switch

E-no
*18 150 07



1-way socket outlet with USB

E-no
*18 150 04



Centre plate USB
USB-port x 2

E-no
*18 151 87
*51 005 04



Centre plate, Jussi, 2xRJ45
RJ45-insert, 2xKeystone

E-no
*51 008 71
*18 153 63



DKS centre plate, Jussi
Washer DKS system,
D-connector 9-way

E-no
*51 008 35
*18 151 34



Impressivo

AUD 21 junction box ProDuct
AUD 31 end package

E-no
11 746 16
11 746 07



Switch Stairs/1-pole

E-no
*18 165 57



Switch crown

E-no
*18 165 51



Pushbutton spri. return 1-pole

E-no
*18 165 69



2-pole switch

E-no
*18 165 45



1-way socket outlet with USB

E-no
*18 150 09



Centre plate USB
USB-port x 2

E-no
*18 156 79
*51 005 04



Centre plate, Impressivo 2xRJ45
RJ45-insert, 2xKeystone

E-no
*18 151 48
*18 153 63



DKS centre plate, Impressivo
Washer DKS system,
D-connector 9-way

E-no
*18 156 87
*18 151 34

**E-number owned by ABB.*

Contact us

Your natural choice partner!

The email address is written according to the principle firstname.lastname@mpbolagen.se



Viktor Karlsson
Sales Manger
+46 (0)70-219 61 50



Christian Antsvee
Key account manager
+46 (0)70-689 05 39



Anders Karlsson
Marketing Director
+46 (0)383-76 36 12
+46 (0)70-696 36 12



Thomas Petersson
Salesperson,
Stockholm
+46 (0)70-753 70 64

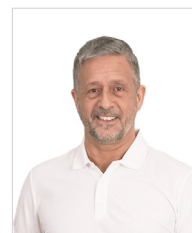

Ronnie Lundh
Salesperson,
Stockholm
+46 (0)72-748 78 88



Kenneth Olofsson
Salesperson, north
+46 (0)70-398 60 20



Elias Kalla
Salesperson, north
+46 (0)72-576 36 37

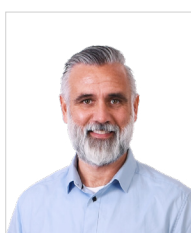

Niklas Karlsson
Salesperson, middle
+46 (0)70-377 36 03



Fredrik Larsson
Salesperson, west
+46 (0)70-248 58 39



Gustav Petersson
Salesperson, east
+46 (0)73-037 80 23



Pontus Olsson
Salesperson, south
+46 (0)73-715 55 96



Patrik Hillström
Product Manager, steel
+46 (0)383-76 36 16
+46 (0)70-661 12 55



Johan Petersson
Export Manager
Electrical prod.
+46 (0)383-76 36 07
+46 (0)70-576 36 07



Peter Fuchs
In-house sales
Manager
+46 (0)383-76 36 09
+46 (0)72-576 36 09



Marcus Gunnevik
In-house salespers.
+46 (0)383-76 36 10
+46 (0)70-336 25 02



Johannes Nordlund
In-house salespers.
+46 (0)383-76 36 05
+46 (0)73-324 40 40



Christian Boman
In-house salespers.
+46 (0)383-76 36 22
+46 (0)70-225 91 08



Susanne Sixtensson
Orders
+46 (0)383-76 36 11



Eva Ferenczy
Orders
+46 (0)383-76 36 18



Maria Johansson
Sales assistant
+46 (0)383-76 36 01

MPbolagen

MP bolagen Industri AB

Box 3

574 21 Vetlanda,

tfn 0383 76 36 00

info@mpbolagen.se

www.mpbolagen.se